



ELECTRÓNICA • INDUSTRIAL

CATÁLOGO



E·MC

HNC

Electric
MÉXICO



En **GEMI**, nos hemos especializado en la reparación y mantenimiento de equipos electrónicos industriales.

Desde hace **21 años**, trabajamos en este campo profesional con resultados exitosos, entendiendo las necesidades de nuestros clientes y cumpliendo con sus expectativas.



Brindamos nuestros servicios a todo el país.

GEMI, es distribuidor autorizado de las mejores marcas , lo que garantiza un mejor precio ante revendedores y un mejor tiempo de entrega.

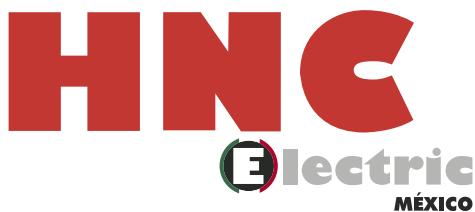

ÍNDICE

OPTEX FA ◇ ◇ ◇ ◇ ◇ ◇ ◇ ◇ ◇ ◇ ◇ ◇ ◇ ◇ ◇ ◇

HNC ◇ ◇ ◇ ◇ ◇ ◇ ◇ ◇ ◇ ◇ ◇ ◇ ◇ ◇ ◇ ◇

CNC ◇ ◇ ◇ ◇ ◇ ◇ ◇ ◇ ◇ ◇ ◇ ◇ ◇ ◇ ◇ ◇

ROBOTS ◇ ◇ ◇ ◇ ◇ ◇ ◇ ◇ ◇ ◇ ◇ ◇ ◇ ◇ ◇ ◇

MEDIA TENSION ◇ ◇ ◇ ◇ ◇ ◇ ◇ ◇ ◇ ◇ ◇ ◇ ◇ ◇ ◇ ◇

E MC ◇ ◇ ◇ ◇ ◇ ◇ ◇ ◇ ◇ ◇ ◇ ◇ ◇ ◇ ◇ ◇

CILINDROS ◇ ◇ ◇ ◇ ◇ ◇ ◇ ◇ ◇ ◇ ◇ ◇ ◇ ◇ ◇ ◇

ELECTROVÁLVULA ◇ ◇ ◇ ◇ ◇ ◇ ◇ ◇ ◇ ◇ ◇ ◇ ◇ ◇ ◇ ◇

FILTRO DE AIRE, REGULADOR Y LUBRICADOR ◇ ◇ ◇ ◇ ◇ ◇

ACCESORIOS ◇ ◇ ◇ ◇ ◇ ◇ ◇ ◇ ◇ ◇ ◇ ◇ ◇ ◇ ◇ ◇

CONTRINEX ◇ ◇ ◇ ◇ ◇ ◇ ◇ ◇ ◇ ◇ ◇ ◇ ◇ ◇ ◇ ◇

3

4

8

9

11

12

13

17

22

28



**Sensores para Automatización Industrial
con Funciones Adicionales**

Hacen realidad la linealidad n.º 1 del mundo.



**SENSORES DE
DESPLAZAMIENTO**



SENSORES LÁSER



**SENSORES DE AJUSTE DE
DISTANCIA BGS/TOF**



**MÓDULOS DE
COMUNICACIÓN**



**SENSORES
FOTOELECTRICOS**



**SENSORES DE DETECCIÓN
DE OBJETOS
TRANSPARENTES**



**SENSORES DE
MARCA DE COLOR**



**TERMÓMETROS DE
MEDICIÓN SIN
CONTACTO**



**AMPLIFICADORES DE
FIBRA ÓPTICA**



**SENSORES
DE CONTRASTE Y
COLOR**

HNC

HNC
Electric
MÉXICO



HNC es uno de los principales fabricantes en el campo de la Automatización, CNC y Media Tensión en el mundo, dedicados a la innovación y desarrollo de productos de Automatización y CNC, ha contribuido a la automatización de maquinaria industrial, ofreciendo sistemas de energía eficientes y confiables en aplicaciones y servicios para satisfacer los requisitos del cliente alcanzando una mayor precisión, performance y eficiencia.



AUTOMATIZACIÓN

Ofrecemos una amplia gama de productos con alta fiabilidad, alto rendimiento y características de alta velocidad y comunicación para cualquier marca que se encuentre en el mercado industrial y alta confiabilidad para el usuario final.

AUTOMATIZACION
CNC
ROBOTS
GEAR BOX
MEDIA TENSION



GEMI Electrónica México

PLC's

HNC ofrece una gama completa de PLC's de mayor rendimiento y más estables, con una velocidad de procesamiento avanzada, mayor capacidad de memoria, funciones de comunicación y posicionamiento.



HCA8C



HCA2C



HCA1P



HCA2P



HCA8P



TP25

HMI's

La línea de HMI's cuenta con una apariencia mas estética, alto rendimiento y estabilidad, así como la integración de funciones mas completas.

TP93



TL25

AUTOMATIZACION
CNC
ROBOTS
GEAR BOX
MEDIA TENSION

SERVO MOTOR & SERVO DRIVE

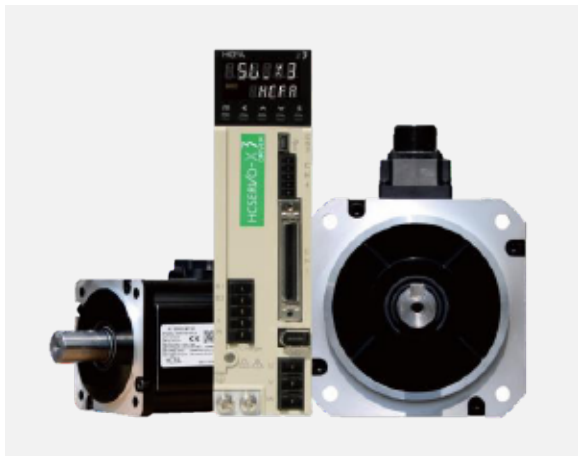

SV-X3E



HSD3

SERVO MOTOR & SERVO DRIVE



HSV-180 AD
HSV-180 AS



HSD2

ARRANCADOR SUAVE

HHS



La serie HHS Soft Starter es un equipo de nueva generación que reemplaza al arrancador estrella-delta convencional, y al arrancador de caída de tensión con auto transformador. Con Capacidades de 11 - 1200 Amperes.

AUTOMATIZACION
CNC
ROBOTS
GEAR BOX
MEDIA TENSION

VARIADORES DE VELOCIDAD

Los variadores HNC, pueden accionar motores de inducción síncronos, asíncronos, servomotores y spindle.



HV590 / 590L



HV390

Modos de control:

- * Pulso
- * Señal analógica
- * Bus de campo
- * Señal de entrada digital
- * Control por Keyboard

Capacidades desde ¼ - 840 HP
Sistemas a lazo abierto y/o lazo cerrado
Control vectorial y control en V/F

HSD2



VARIADORES PARA BOMBEO SOLAR



HV500P

Aplicaciones:

Se utiliza principalmente para la agricultura y el riego forestal, el control del desierto, la ganadería de pastizales, el agua urbana y otros campos.

AUTOMATIZACION
CNC
ROBOTS
GEAR BOX
MEDIA TENSION

Los controladores CNC adoptan una arquitectura abierta avanzada, una computadora personal industrial (IPC) incorporada. Integran varias interfaces para eje de alimentación, spindle, unidades de mando y PLC integrado, adoptan almacenamiento en disco de alta capacidad y comunicaciones de USB, DNC y Ethernet.

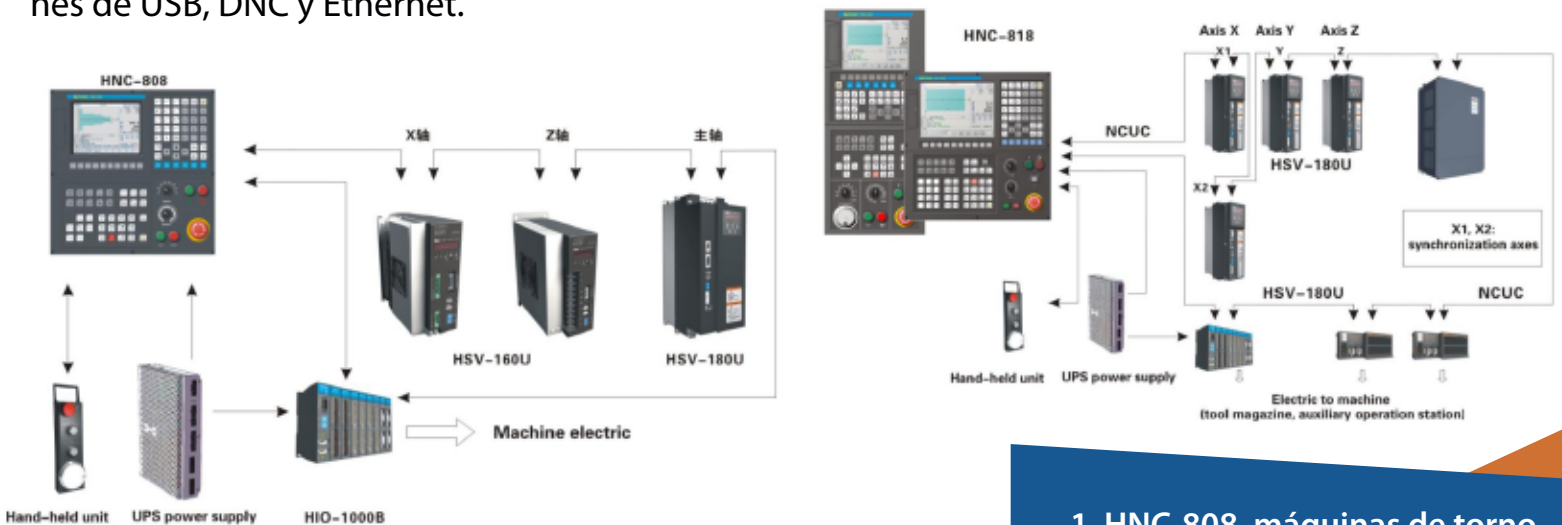

1. HNC-808, máquinas de torno.
2. HNC-818, fresadoras y centros de maquinados
3. HNC-848, centros de maquinados hasta 5 ejes

ROBOTS

ROBOTS



HNC ofrece una completa gama de robots para ayudar a los fabricantes a mejorar sus líneas de producción.

SERIE HSR-BR

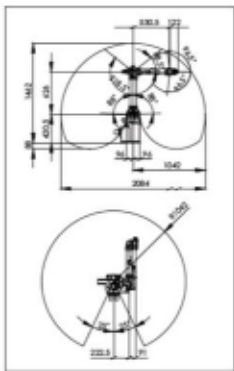

SERIE HSR-JR

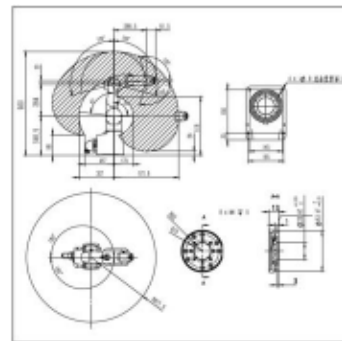

SERIE HSR-HC

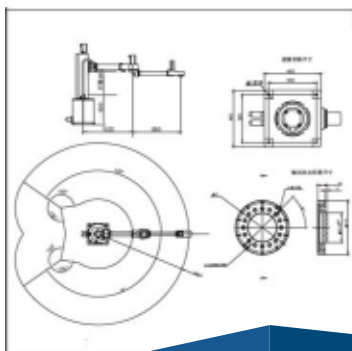

El robot HNC Electric tiene 5 series con mas de 30 especificaciones, diseñados para otorgar precisión y velocidad a las exigentes aplicaciones de manufactura de hoy en día

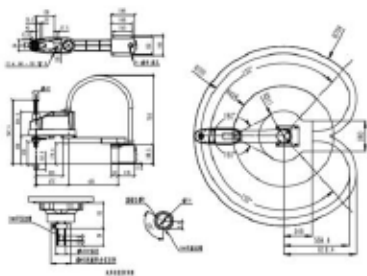

SERIE HSR-SR



SERIE HSR-DT



GEARBOX



Los GearBox HNC son un componente mecánico estándar para la aplicación en servomotores. Puede admitir el servomotor HNC y servomotor de cualquier otra marca.

Fabricados en maquinas CNC, bajo un tratamiento térmico; el GearBox puede utilizarse ampliamente en muchas aplicaciones, como máquinas de embalaje, fresadoras CNC, servo transportadoras, alimentadores, etc. con alto par de salida, funcionamiento estable y libre de mantenimiento. Tenemos colineales y a 90°, con brida, sin brida, y relaciones de reducción de 1-3 hasta 1-1000.



MEDIA TENSION



HNC tiene las soluciones inteligentes para el control de motores de media tensión, la familia de variadores y arrancadores de media tensión de HNC, solucionan una variedad de aplicaciones de trabajo pesado.

Si el trabajo requiere de control para motores de inducción, se puede especificar para controlar motores asíncronos o síncronos, ya sea rotor devanado o imán permanente, con voltajes de 3 KV-23 KV y capacidades hasta 33,500 HP.



HMV1000



HMS

HMV3000



- * Bombas
- * Ventiladores y sopladores
- * Trituradoras y llenadoras
- * Transportadores
- * Molinos de bolas, de martillo o laminadores
- * Enfriadores
- * Centrifugas y compresores



E · MC

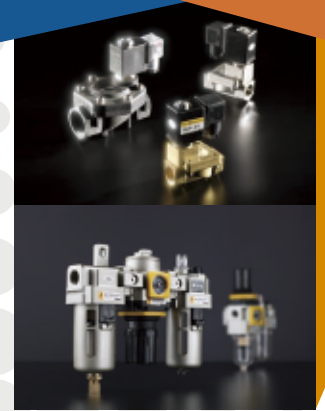

E.MC se centra en la I+D de tecnología de automatización industrial, la innovación de productos y la aplicación industrial. Nuestro objetivo es ayudar a los clientes a alcanzar el objetivo de la máxima eficiencia de producción, ofreciendo sistemas neumáticos de alta eficiencia, inteligentes, precisos y de bajo consumo y una solución completa de automatización de la industria.

Desde su fundación en 1986, E.MC experimentó más de 30 años de innovación continua, superación y avance propio, y se convierte en una nueva empresa nacional de alta tecnología con investigación y desarrollo, fabricación y operación de marca. En 2010, con una sólida experiencia en energía fluida y sistemas electromecánicos en la universidad de Zhejiang, E.MC estableció un centro de investigación y desarrollo de automatización industrial y neumática de clase nacional en China, que brinda una ventaja competitiva líder absoluta en los campos de investigación y desarrollo de tecnología, innovación de producción, reingeniería de procesos, Aplicación del sistema y solución de automatización completa.

Hoy en día, todos los clientes de E.MC disfrutan convenientemente:

Productos de alta calidad de E.MC y servicio de oro a través de nuestro amplio canal de mercado y red de servicio en Europa, en el área grande de América, en el Medio Oriente... cerca de 117 países y 82 ciudades en todo el mundo .

En el futuro, E.MC continuará siguiendo el concepto central "la innovación crea valor", pasará por las nuevas etapas para la innovación de productos, la innovación de procesos y la innovación de servicios. Crearemos más valor para los clientes, aumentaremos la eficiencia para la producción de la sociedad, lideraremos la tecnología de automatización hacia un futuro sistemático, flexible, integrado e inteligente con cada esfuerzo.



Hoy, E.MC disfruta de:

- * Más de 85.000 m2 tres fábricas
- * Más de 100 instalaciones de clase mundial
- * Más de 40 ingenieros de I+D dirigidos por médicos y profesores
- * más de 50 derechos de patente
- * 60+ ingeniero de ventas
- * más de 500 empleados

CILINDROS

SERIE CILINDRO ESTÁNDAR



FVBC / FXBC Serie Cilindro Estándar

FVBC Series Cylinder



FVBC 63x100

FXBC 32x100

VBC / LBC Serie Cilindro Estándar

VBC Series Cylinder



VBC 40x150

LBC 32x150

VD C 63x150

VAC 63x125-50

TBC/XBC Serie Cilindro Estándar

TBC/XBC Series Cylinder

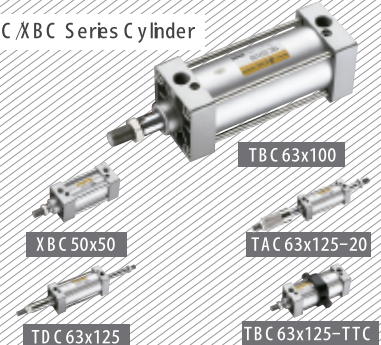

TBC 63x100

XBC 50x50

TAC 63x125-20

TD C 63x125

TBC 63x125-TTC

IAS Serie Mini Cilindro

IAS Series Cylinder



IAS 25x50-S

RAL/RAS Serie Mini Cilindro

RAL,RAS Series Cylinder



RAL20x100

RAL-U 20x80

RJL32x40

RACS 20x75

RAS 25x75

SERIE MINI CILINDRO



CILINDROS

SE Serie Europea Estandar Cilindro Compacto

SE Series Cylinder



SE 25x5

SE 20x5

SD Serie Cilindro Compacto

SD Series Cylinder

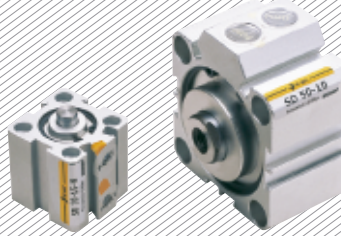

SD 20x15-N

SD 50x10

SQ Serie Cilindro Compacto

SQ Series Cylinder



SQ 32x10-S-Z

SQ 25x100

SQ 25x15-S-Z

ERQ Cilindro de tope de serie

ERQ Series Cylinder

ERQ A60x75R



SW Serie Cilindro sin vástago

SW Series Cylinder

SW B 15x125

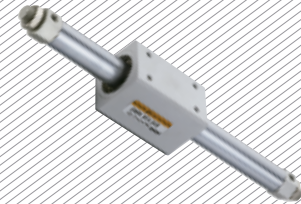

PCK Cilindro de sujecion en serie

PCK series clamp cylinder

PCK-50x550-S-Y



PHC Cilindro Hidroneumático

PHC Series Cylinder

PHC S 80x180-5

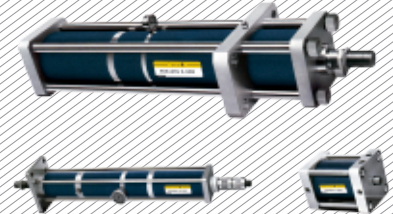

EU Serie Cilindro libre de Instalacion

EU Series Cylinder

EU 16x15



EN Cilindro de doble eje serie

EN Series Cylinder

EN 16x100

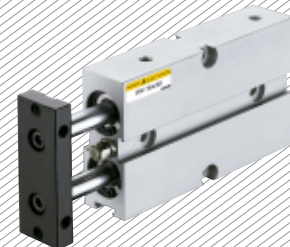

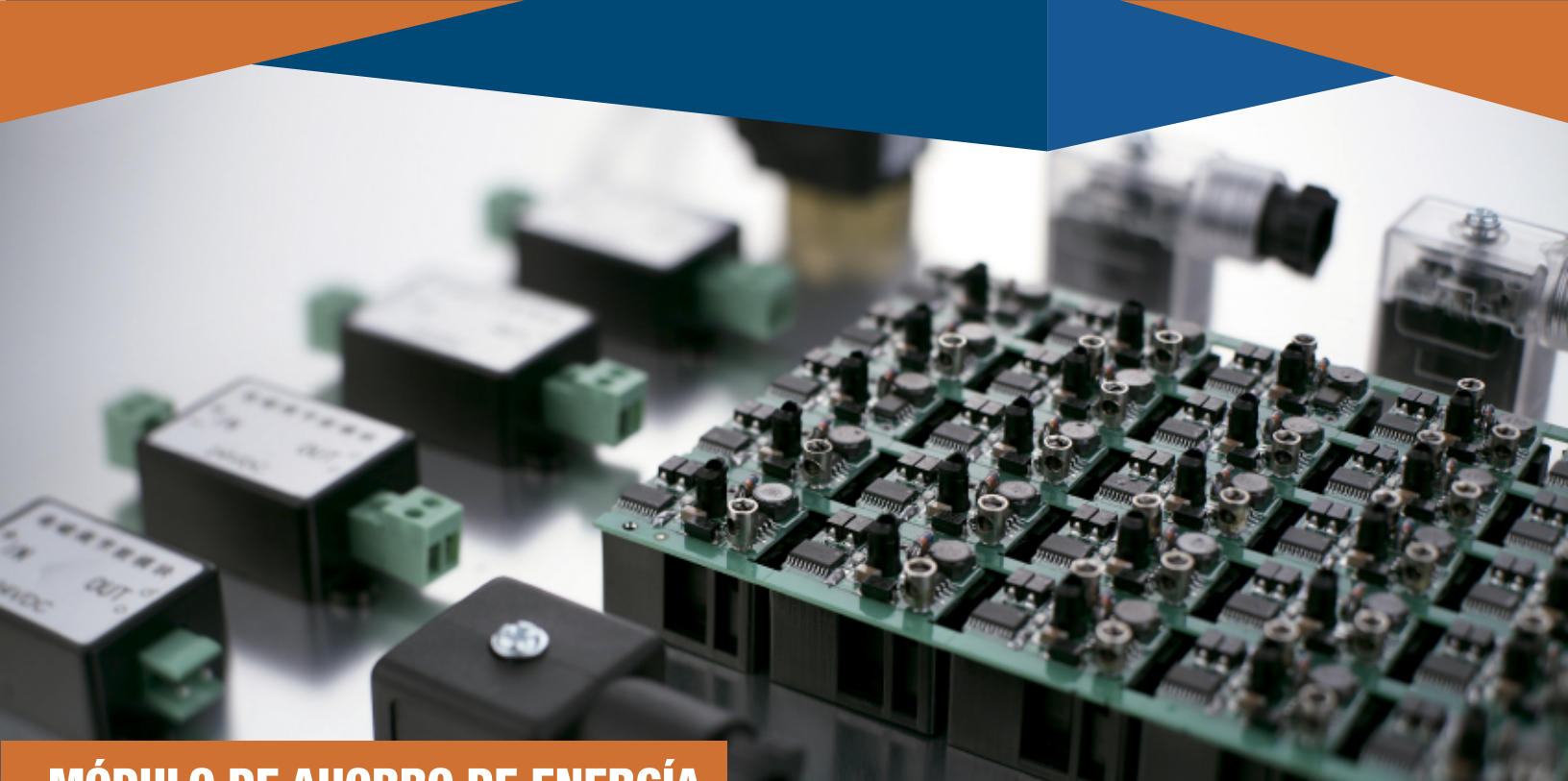

MÓDULO DE AHORRO DE ENERGÍA

Módulo de ahorro de energía de uso de válvula solenoide (parámetros fijos)

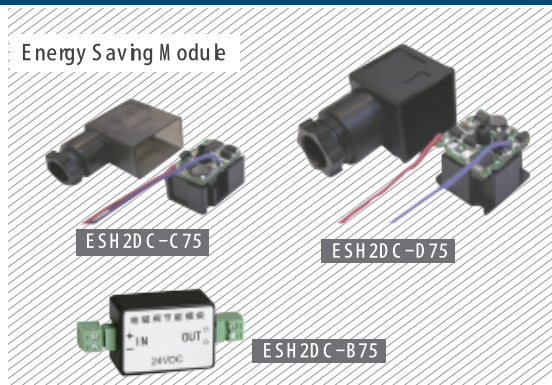

Energía de ahorro de energía de uso general (parámetros ajustables)



No accionado por energía (señal IN que funciona tanto como energía señal de suministro y control), muy conveniente Rendimiento de ahorro de energía extremadamente sorprendente (50%- 90% abajo), bobina de enfriamiento y vida útil prolongada. El estilo del conector DIN hace que la válvula sea más compacta. Regulable hasta 2000HZ de alta frecuencia Velocidad de respuesta del aumento de presión ESH2DC-A75 módulo aumenta 40%.

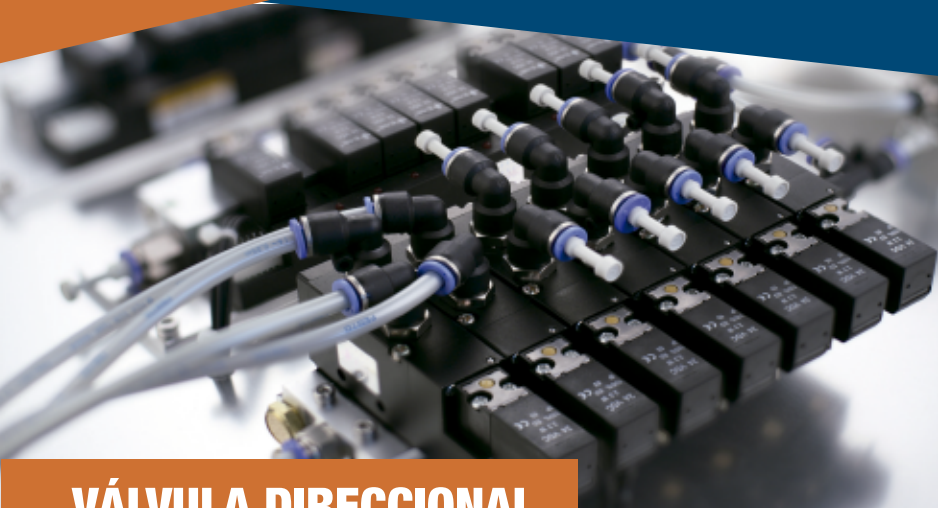

VÁLVULA DIRECCIONAL

Rápida respuesta, alta estabilidad.
 Bajo poder, alta eficacia.
 Fabricación de máquinas CNC en EE. UU.
 Productos destacados para optimización de procesos. Garantía de calidad desde la automatización completa prueba de todo el proceso de montaje. Sellado y grasa importados. Producción de piloto de solenoide profesional importado línea de corriente. Mínimo magnetismo residencial con postratamiento especial.



PLC Control directo
 Multiconexión e interfaces.
 Bajo poder, gran flujo.
 Modularidad de integración compacta

VI Series Valve Island
 V B21E4-6L



ISLA DE VÁLVULAS

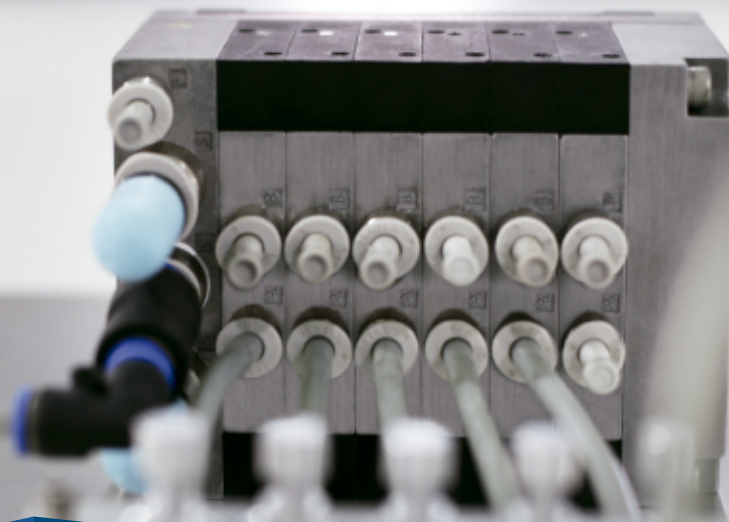

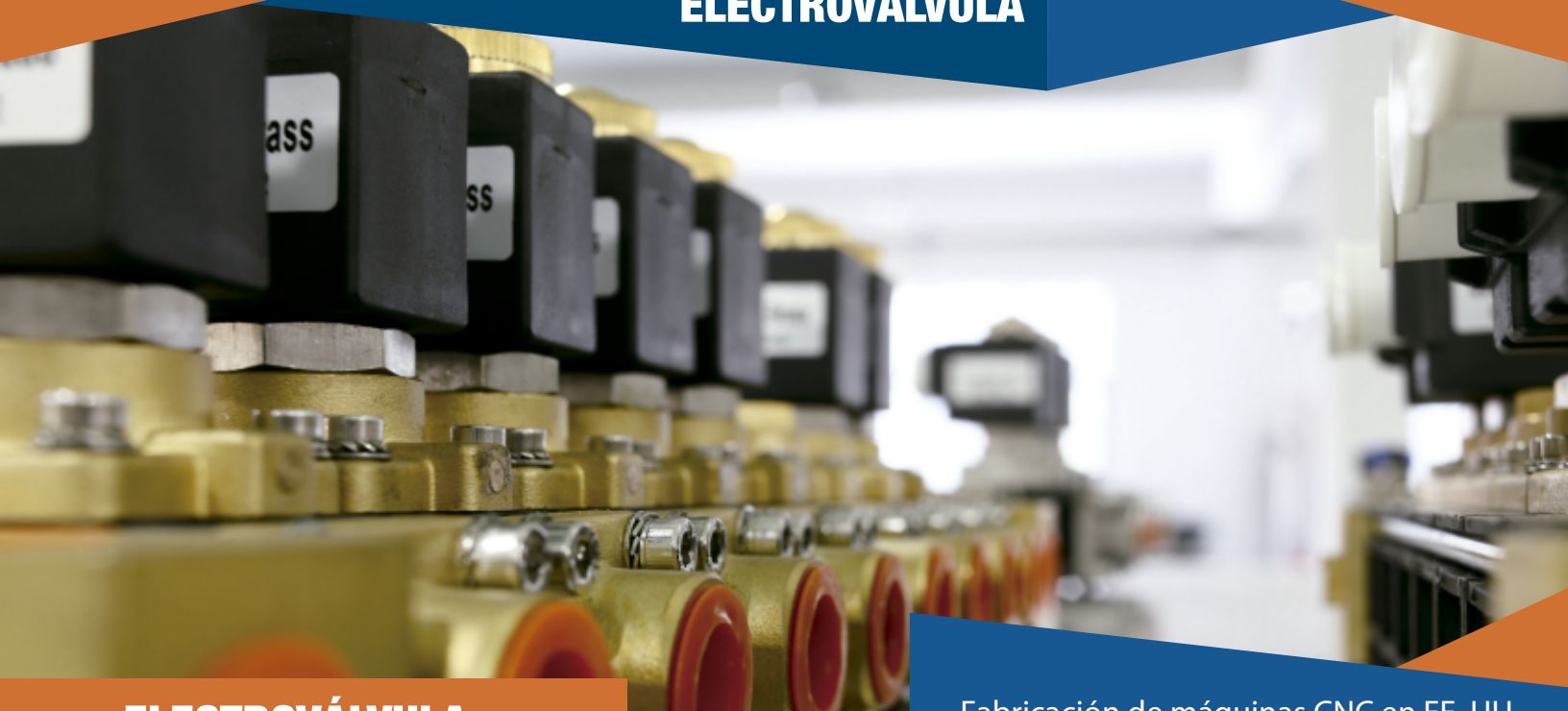

ELECTROVÁLVULA

ESLP Series 2/2 Solenoid Valve

- 1.ESLP
- 2.ESLP-H

New Technology

N.O. and N.C. interchange,
1/2"~1"



ZS-H 2/2 Solenoid Valve

- 1.ZS10E2-16LH
- 2.ZS15E2-16LS2H



SLP Series 2/2 Solenoid Valve

- 1.SLP
- 2.SLP-S1
- 3.SLPF-S1

16 Bar, 1/8"~4"



Fabricación de máquinas CNC en EE. UU.

Más de 20 años de experiencia en electroválvulas y bobinas fabricación.

La opción de consumo súper bajo de 2~8W ofrece la única solución para un gran problema de

sobrecalentamiento de las válvulas de solenoide en mucha temperatura más baja, ciclo de vida más largo, respuesta más rápida, uso más seguro

Grandes tamaños desde 1mm hasta 300mm, presión máxima podría ser más de 100 bar, rangos de temperatura que cubren desde -200 centígrados hasta +250 centígrados. La alta calidad del

perfecto diseño y composición de sellado y otras partes en contacto con fluidos, proporciona. Sistema completo de prueba automática de electroválvulas.

ELECTROVÁLVULA

ELECTROVÁLVULA ESP SERIE 2/2

ESP Series Solenoid Valve

ESP-10

Available in both N.O. and N.C.,
3/8"~1-1/4"



ELECTROVÁLVULA SERIE ZSP

ZSP Series Solenoid Valve

ZSP-15



ELECTROVÁLVULA SERIE UD 2/2

UD Series Solenoid Valve

UD-06



ELECTROVÁLVULA SERIE UW 2/2

UW Series Solenoid Valve

UW-15

3/8"~2"



ELECTROVÁLVULA SERIE UWS 2/2

UWS Series Solenoid Valve

UWS-06E2



ELECTROVÁLVULA PU 2/2

2V Series Solenoid Valve

1. 2V025-08E2
2. 2V130-15E2



ELECTROVÁLVULA SERIE ÁNGULO COMPLETO DE ACERO INOXIDABLE

EMC Series Angle Valve

EM C015-50A
180°C, 3/8"~2"



EMCP Series Angle Valve

EM CP015-50AS1
180°C, 3/8"~2"



ELECTROVÁLVULA SERIE 2/2 PILOTO-DIAFRAGMA

EM C Series Solenoid Valve

1. EM C008BE2
2. EM C040BE2

Popular Europe type,
available in both N.C. and N.O., 1/4"~2"

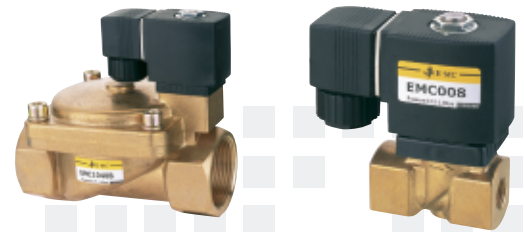

PU 2/2 Solenoid Valve (Normal base)

1. PU 220E4-03S
2. PUT220E2-06

Automatic draining, 3/8"~1"



ELECTROVÁLVULA PU 2/2

* Bombas

* Ventiladores y sopladores

* Trituradoras y llenadoras

* Transportadores

* Molinos de bolas, de martillo o laminadores

* Enfriadores

* Centrifugas y compresores

ELECTROVÁLVULA

EMCF SERIE 2/2 VÁLVULA DE PULSO

EMCF Series Solenoid Valve

- 1.EMCF-25
- 2.EMCF-50

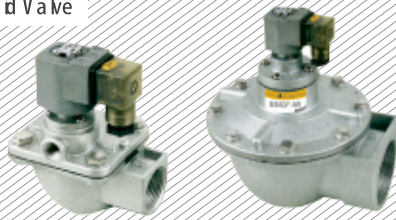

EMCYF SERIE 2/2 VÁLVULA DE PULSO

EMCYF Series Solenoid Valve

- 1.EMCYF-50E2



SLG SERIE 2/2 ELECTROVÁLVULA

SLG Series Solenoid Valve

- 1.SLG 22-06E2



ACV ELECTROVÁLVULA DE PLÁSTICO

ACV Series Solenoid Valve

- 1.AC V08E2-6L
- 2.AC V15E2-15L

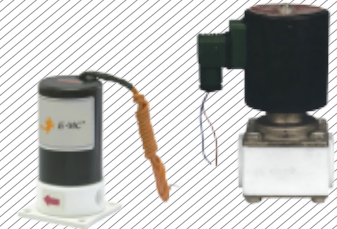

MINI ELECTROVÁLVULA



Type:2/2 nom alcbse
Port Size:1/8"
Orifice:0.8mm
Pressure:0-8Bar
Temperature:-5-80°C
Material:Brass
Seal Material:NBR



Type:2/2 nom alcbse
Port Size:M5
Orifice:1.2mm
Pressure:0-8Bar
Temperature:-5-80°C
Material:Brass
Seal Material:NBR



Model:Q 22XD-2L Q 22XD-3L Q 22XD-4L Q 22XD-5L Q 23XD-2L Q 23XD-3L Q 22XD-4L Q 23XD-5L
Type:Nom alcbse, Normal open (Optional)
Port Size:1/8" 1/4"
Orifice:2mm 3mm 4mm 5mm
Pressure:0-8Bar
Temperature:-5-80°C
Material:Brass
Seal Material:NBR Viton



Model:G L23-06-2L
G L23-06-3L
Type:3/2 nom alcbse
Port Size:1/8" 1/4"
Orifice:2mm 3mm
Pressure:0-8Bar
Temperature:-5-80°C
Material:Brass
Seal Material:NBR



Model:G 22-06-3L
Type:2/2 nom alcbse
Port Size:1/8"
M 12x1.25
Orifice:3mm
Pressure:0-8Bar
Temperature:-40-150°C
Material:Brass
Seal Material:NBR

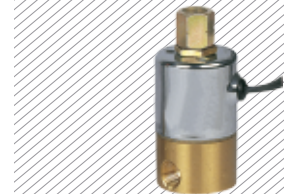

Model:G CH23-M
Type:3/2 nom alcbse
Orifice:1.2mm
Pressure:0-14Bar
Temperature:80-160°C
Material:Brass



Model:EF23-08H
Type:3/2 nom alcbse
Port Size:1/4"
Pressure:0-16 Bar
Temperature:0-160°C
Material:Brass



Model:EM C22-M 5
Type:2/2 nom alcbse
Port Size:5mm
Orifice:1mm
Pressure:0-8Bar
Temperature:-5-85°C
Material:PP



Model:ETS23
Type:3/2 nom alcbse
Port Size:In=6mm Pipe
Outlet=6*1
Orifice:1.4mm
Pressure:0-2.4Bar
Material:Reinforced Nylon



Model:G U23-0.6-1.5L G U23-0.6-1.5LH
Type:3/2 nom alcbse, normal open (Optional)
Port Size:1/4"
Orifice:1.5mm 2mm
Pressure:0-8Bar
Temperature:-5-80°C
Material:Brass
Seal Material:NBR

ELECTROVÁLVULA



VÁLVULA DIRECCIONAL

 **E·MC** GOOD TO  **GRE**

ELECTROVÁLVULA DE BAJO PODER



ELECTROVÁLVULA

RV ELECTROVÁLVULA SERIE DE BAJA PODER 3/2

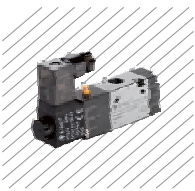

N1R231-M5
N1R231-06
N2R231-06
N2R231-08
N3R231-08
N3R231-10
N4R231-10
N4R231-15

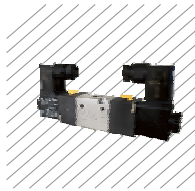

N1R232-M5
N1R232-06
N2R232-06
N2R232-08
N3R232-08
N3R232-10
N4R232-10
N4R232-15

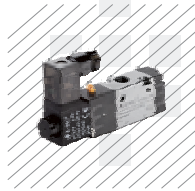

N1R231H-M5
N1R231H-06
N2R231H-06
N2R231H-08
N3R231H-08
N3R231H-10
N4R231H-10
N4R231H-15

RV CONTROL DE AIRE 3/2

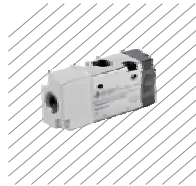

RVA3211-M5
RVA3211-06
RVA3221-06
RVA3221-08
RVA3231-08
RVA3231-10
RVA3241-10
RVA3241-15

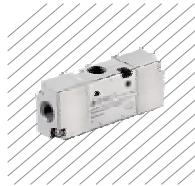

RVA3212-M5
RVA3212-06
RVA3222-06
RVA3222-08
RVA3232-08
RVA3232-10
RVA3242-10
RVA3242-15

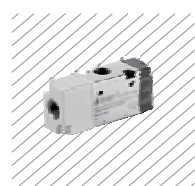

Model:
RVA3211H-M5
RVA3211H-06
RVA3221H-06
RVA3221H-08
RVA3231H-08
RVA3231H-10
RVA3241H-10
RVA3241H-15

RV ELECTROVÁLVULA SERIE ESTANDART 3/2

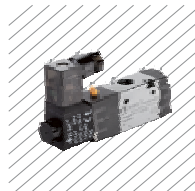

Model:
RV3211-M5
RV3211-06
RV3221-06
RV3221-08
RV3231-08
RV3231-10
RV3241-10
RV3241-15

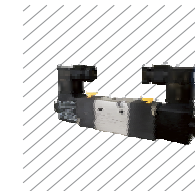

Model:
RV3212-M5
RV3212-06
RV3222-06
RV3222-08
RV3232-08
RV3232-10
RV3242-10
RV3242-15

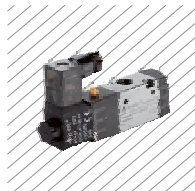

Model:
RV3211H-M5
RV3211H-06
RV3221H-06
RV3221H-08
RV3231H-08
RV3231H-10
RV3241H-10
RV3241H-15

V ELECTROVÁLVULA SERIE ESTANDAR NAMUR 3/2

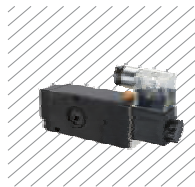

Model:
V3211-M5M
V3211-06M
V3221-06M
V3221-08M
V3231-08M
V3231-10M
V3241-10M
V3241-15M

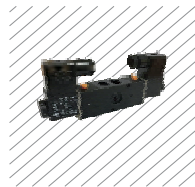

Model:
V3212-M5M
V3212-06M
V3222-06M
V3222-08M
V3232-08M
V3232-10M
V3242-10M
V3242-15M

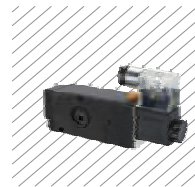

Model:
V3211H-M5M
V3211H-06M
V3221H-06M
V3221H-08M
V3231H-08M
V3231H-10M
V3241H-10M
V3241H-15M

V SERIE NAMUR CONTROL DE AIRE 3/2



Model:
VA3211-M5M
VA3211-06M
VA3221-06M
VA3221-08M
VA3231-08M
VA3231-10M
VA3241-10M
VA3241-15M

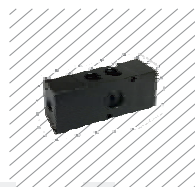

Model:
VA3212-M5M
VA3212-06M
VA3222-06M
VA3222-08M
VA3232-08M
VA3232-10M
VA3242-10M
VA3242-15M



Model:
VA3211H-M5M
VA3211H-06M
VA3221H-06M
VA3221H-08M
VA3231H-08M
VA3231H-10M
VA3241H-10M
VA3241H-15M



FILTRO DE AIRE, REGULADOR Y LUBRICADOR

EI SERIE – FUENTE DE AIRE EN UNIDAD DE TRATAMIENTO.



Model
E K 2000-01
E K 2000-02



Model
E K 3000-02
E K 3000-03
E K 4000-04
E K 5000-06
E K 5000-10



Model
E W 2000-01
E W 2000-02



Model
E W 3000-02
E W 3000-03
E W 4000-04
E W 5000-06
E W 5000-10



Model
E F 2000-01
E F 2000-02



Model
E F 3000-02
E F 3000-03
E F 4000-03
E F 4000-04
E F 5000-06
E F 5000-10



Model
E K 2010-01
E K 2010-02



Model
E K 3010-02
E K 3010-03
E K 4010-04
E K 5010-06
E K 5010-10



Model
E L 3010-02
E L 3010-03
E L 4010-03
E L 4010-04
E L 5010-06
E L 5010-10



Model
E L 2000-01
E L 2000-02



Model
E R 2000-01
E R 2000-02
E R 3000-02
E R 3000-03
E R 4000-04
E R 5000-06
E R 5000-10

Estructura de diafragma, con fuerza de resorte adecuada después prueba y demostración, para asegurarse de que el mejor regulador rendimiento de presión. Diseño de estructura especial del lubricador, adición de aceite en cualquier momento sin dejar de trabajar. Amplia aplicación con policarbonato al agua y taza de bobina. La serie E/EI FRL actualizada, con ingenieros de E.MC Estudio profundo, prueba y diseño de cuerpo especial, admite más de 9 bar en la aplicación real mientras es normal. Los engrasadores FRL se rompen por un uso prolongado, lo que de muestra lo mejor Tecnología en FRL.

E SERIE – FUENTE DE AIRE EN UNIDAD DE TRATAMIENTO.



EC 2000-02



EC 3000-02
EC 3000-03
EC 4000-03
EC 4000-04
EC 4000-06



Model
EC 5010-06
EC 5010-10



EW 2000-01
EW 2000-02



Model
EC 1010-M 5
EC 2010-01
EC 2010-02



Model
EC 3010-02
EC 3010-03
EC 4010-03
EC 4010-04
EC 4010-06



Model
EC 5010-06
EC 5010-10



Model
EW 3000-02
EW 3000-03
EW 4000-03
EW 4000-04
EW 4000-06



Model
EL1000-M 5
EL2000-01
EL2000-02



Model
EL3000-02
EL3000-03
EL4000-03
EL4000-04
EL4000-06



Model
EL5000-06
EL5000-10



Model
EW 5000-06
EW 5000-10



Model
EF1000-M 5
EF2000-01
EF2000-02



Model
EF3000-02D
EF3000-03D
EF4000-03D
EF4000-04D
EF4000-06D



Model
EF3000-02
EF3000-03
EF4000-03
EF4000-04
EF4000-06



Model
EF5000-06
EF5000-10



Model
ER1000-M 5 ER 2000-01
ER 2000-02 ER 2500-02
ER 2500-03 ER 3000-02
ER 3000-03 ER 4000-03
ER 4000-04 ER 4000-06
ER 5000-06 ER 5000-10

HE SERIE – FUENTE DE AIRE UNIDAD DE TRATAMIENTO.



Model
HEC 2000-01
HEC 2000-02



HEC 3000-02
HEC 3000-03
HEC 4000-04
HEC 4000-06
HEC 4000-06



Model
HEC 5000-06
HEC 5000-10



Model
HEW 2000-01
HEW 2000-02



Model
HEC 2010-01
HEC 2010-02



Model
HEC 3010-02
HEC 3010-03
HEC 4010-03
HEC 4010-04
HEC 4010-06



Model
HEC 5010-06
HEC 5010-10



Model
HEW 3000-02
HEW 3000-03
HEW 4000-04
HEW 4000-04
HEW 4000-06



Model
HEF 2000-01
HEF 2000-02



Model
HEF 3000-02
HEF 3000-03
HEF 4000-04
HEF 4000-04
HEF 4000-06



Model
HEF 5000-06
HEF 5000-10



Model
HEW 5000-06
HEW 5000-10



Model
HEL 2000-01
HEL 2000-02



Model
HEL 3000-02
HEL 3000-03
HEL 4000-03
HEL 4000-04
HEL 4000-06



Model
HEL 5000-06
HEL 6000-10



Model
HR 2000-01 HR 2000-02
HR 3000-02 HR 3000-03
HR 4000-03 HR 4000-04
HR 4000-06 HR 5000-06
HR 5000-10



ACCESORIOS

- Producción en masa automática
- Montaje y pruebas automáticas
- Todas las piezas se proporcionan por cuenta propia

E SERIE – FUENTE DE AIRE EN UNIDAD DE TRATAMIENTO.

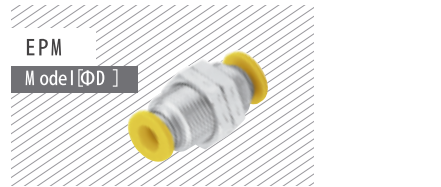
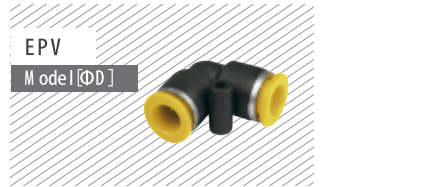
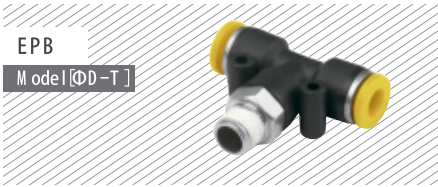
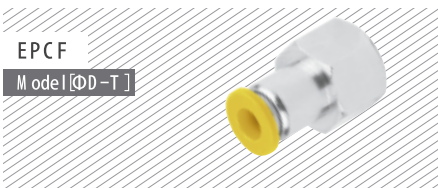

ACCESORIO ESTILO EE. UU. / ACCESORIO DE METAL

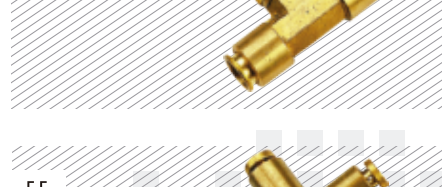
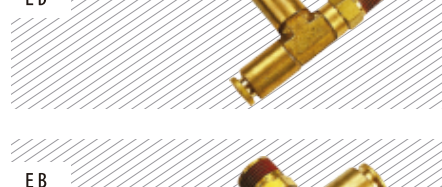
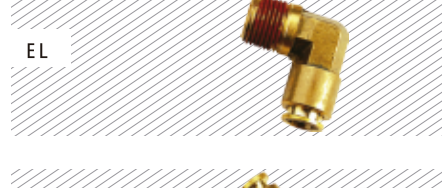

CONEXIÓN DE UN TOQUE DE METAL ESTILO ITALIANO

EM E

Model [ΦD]



Model:

EM E3 EM E4 EM E6 EM E8 EM E10

EM Y

Model [ΦD]

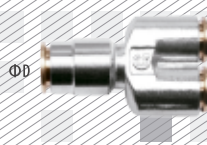

Model:

EM Y4 EM Y6 EM Y8 EM Y10

EM U

Model [ΦD]



Model:

EM U3 EM U4 EM U6 EM U8 EM U10

EM V

Model [ΦD]



Model:

EM V3 EM V4 EM V6 EM V8 EM V10

EM ZA

Model [ΦD]

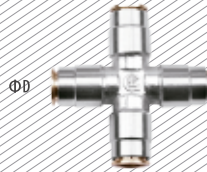

Model:

EM ZA3 EM ZA4 EM ZA6 EM ZA8 EM ZA10

EM M

Model [ΦD]

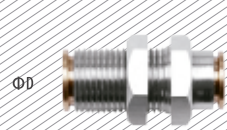

Model:

EM M3 EM M4 EM M6 EM M8 EM M10

SS ACCESORIO DE UN TOQUE

ESPU

Model [ΦD]

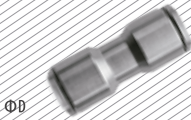

Tube Metric:

ESPU 4 ESPU 6 ESPU 8 ESPU 10 ESPU 12

ESPV

Model [ΦD]

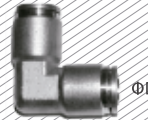

Tube Metric:

ESPV 4 ESPV 6 ESPV 8 ESPV 10 ESPV 12

ESPE

Model [ΦD]



Tube Metric:

ESPE 4 ESPE 6 ESPE 8 ESPE 10 ESPE 12

CONEXIÓN INSTANTÁNEA DE LATÓN

EM PY

Model [ΦD]



EM PC-G

Model [ΦD-T]



EM PCF-G

Model [ΦD-T]



EM PE

Model [ΦD]



EM PL-G

Model [ΦD-T]



EM PB-G

Model [ΦD-T]



EM PM

Model [ΦD]



EM PG J

Model [ΦD1-ΦD2]



EM PSC

Model [ΦD-T]



ACCESORIOS

ACCESORIO ESTILO EE. UU. / ACCESORIO DE METAL

EC



Model:
EC-01 EC-02 EC-03 EC-04

EF-M



Model:
EF-01M EF-02M EF-03M EF-04M
EF-05M

EV



Model:
EV01 EV02 EV03 EV04

EL



Model:
EL01 EL02 EL03 EL04

EF-F



Model:
EF-01F EF-02F EF-03F EF-04F

EH



Tube (Metric):
EH-01 EH-02 EH-03 EH-04

EHU

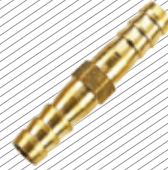

Model:
EHU-01 EHU-02 EHU-03 EHU-04

EHC

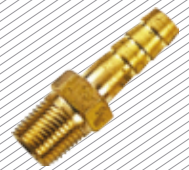

Model:
EHC-01 EHC-02 EHC-03 EHC-04

PRESIÓN DE MONTAJE HIDRÁULICO: 0-600BA

LQ-KT12



LQ-KT17



LQ-KT13



LQ-KT14



LQ-KT15



JUEGOS DE ACOPLADORES RÁPIDOS DE 5 PIEZAS



EQ-01S

5pc 1/4" Industrial type coupler plug kit



EQ-02S

5pc 1/4" NITto type coupler plug kit



EQ-03S

5pc 1/4" Aro type coupler plug kit



EQ-04S

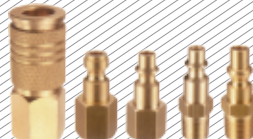

EQ-05S



EQ-06S

CONECTORES GIRATORIOS

E1003-A



E1003-B



E1003-C



E1003-D

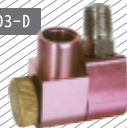

E1003-E

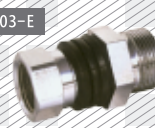

E1003-F



TUBO DE PU TUBO DE PE / TUBO REFORZADO PU / TUBO DE NYLON / CORTADOR DE PU

TUBO PU

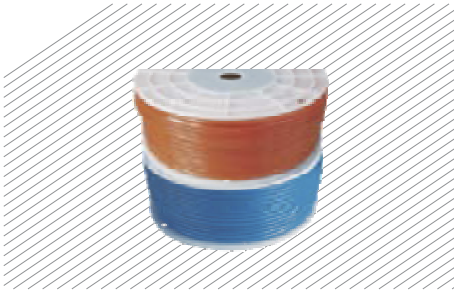

Model:
4x2.5 6x4 8x5 8x6 10x6 5 12x8 14x10 16x12
Type: Roll type
Length: 200m 100m

TUBO PU



Type: Spring type tube (End fitting optional)
Length: 15m 12m 9m 7 5m 6m

TUBO REFORZADO PU

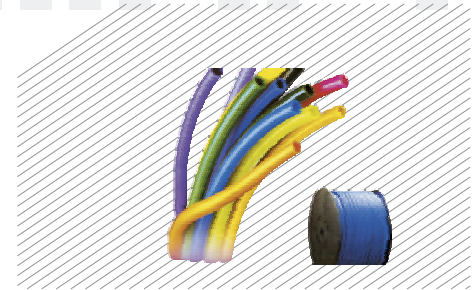

Size: 3/8x1/4 1 2x3 8' 8x5 10x6 5 .11x6 12x8 13x9 13 5x8 .
13.5x9.5 14x10 14 5x10 15x9 16x10 16x11 18x12 18x13
Operating Pressure: 200Psi **Max.Pressure :** 600Psi
Temperature: - 20 65

TUBO PE



Model: 4x2.5 6x4 8x5 8x6 10x6 5 12x8
Type: Roll type Spring type
Length: 200m 100m 50m 35m 30m

TUBO DE NYLON



Model: 3x2 4x2 5 5x3 6x4 8x5 8x6 10x7 5 12x8 14x10 16x12
Type: Roll Type
Length: 200m 100m 50m 35m 30m

CORTADOR DE PU



Model: ECP -01





SMART SENSOR



SENSORES

- SMART
- POCKETCODR
- INDUCTIVO
- ULTRASONICOS
- FOTOELÉCTRICOS

SEGURIDAD

- CORTINAS DE LUZ Y SENSORES

RFID

- ALTA Y BAJA FRECUENCIA



Líder global en tecnología de sensores inteligentes para automatización compleja y aplicaciones en fábricas inteligentes, con 50 años de experiencia.

ACCESORIOS

- CABLES, BRACKETS DE MONTAJE Y REFLECTORES

SOPORTES DE MONTAJE UNIVERSALES

MECHANICAL STOPS

REFLECTORES FOTOELÉCTRICOS

VERIFICADOR DE SENSORES



ASU-0001-080



ASU-0001-120



AMS-0001-M08



AMS-0002-M08



AMS-0001-M12



AMS-0002-M12

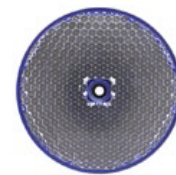

LXU-0000-084



ATE-0000-010

SOPORTES DE MONTAJE FOTOELÉCTRICOS



LXW-C23PA-000



LXW-C23PA-002



LXW-DGMGA-000



LLW-M18PA-000



LXW-M18PA-001



LXU-0001-064



Móvil: **221 174 64 21** 
Mail: **gemiventas1@gmail.com**
gemiventas1@grupoelectronico.com



E·MC



www.grupoelectronico.com